

Seite links

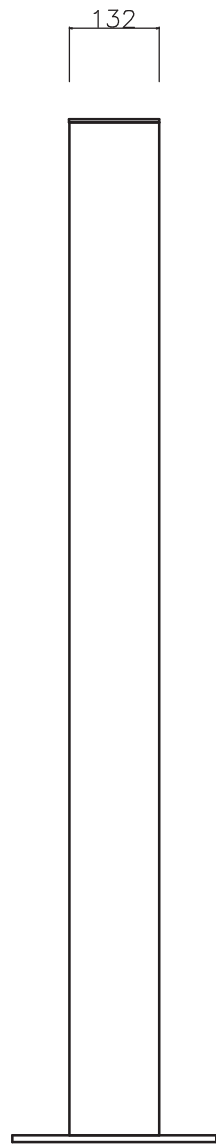

Front

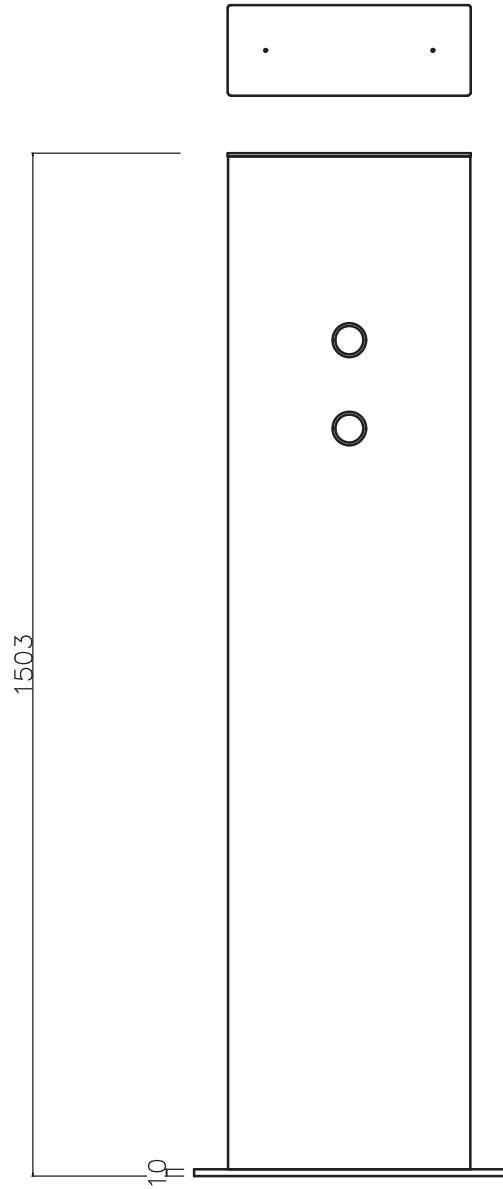

Seite rechts

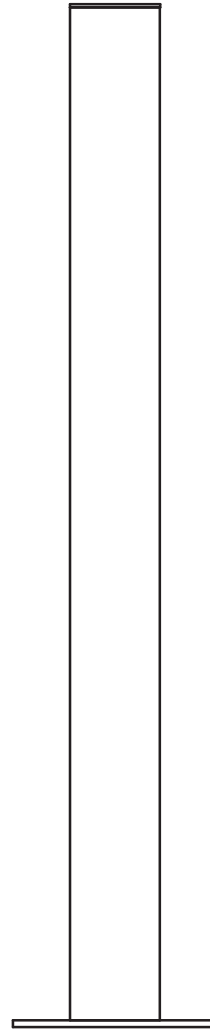

Rückseite

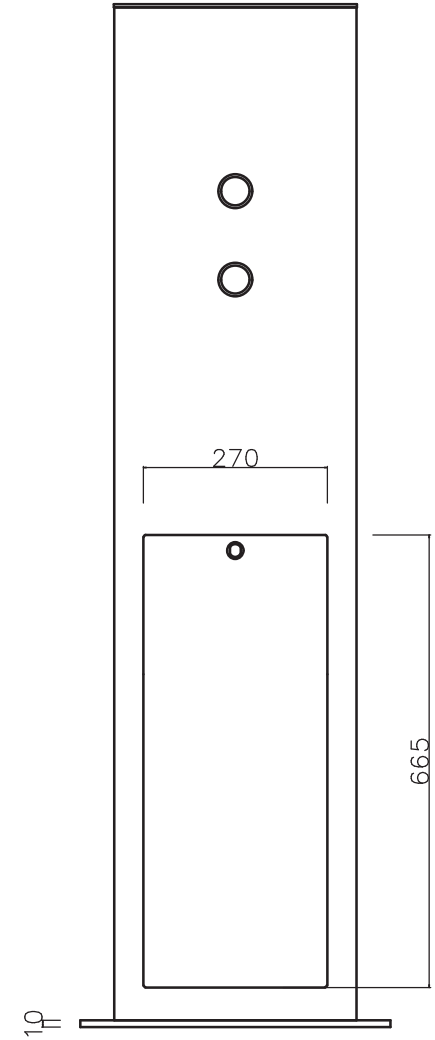

Bezeichnung: Wallbox Ständer DUO DesignLine

Projektleiter:

Datum: 02.04.2019

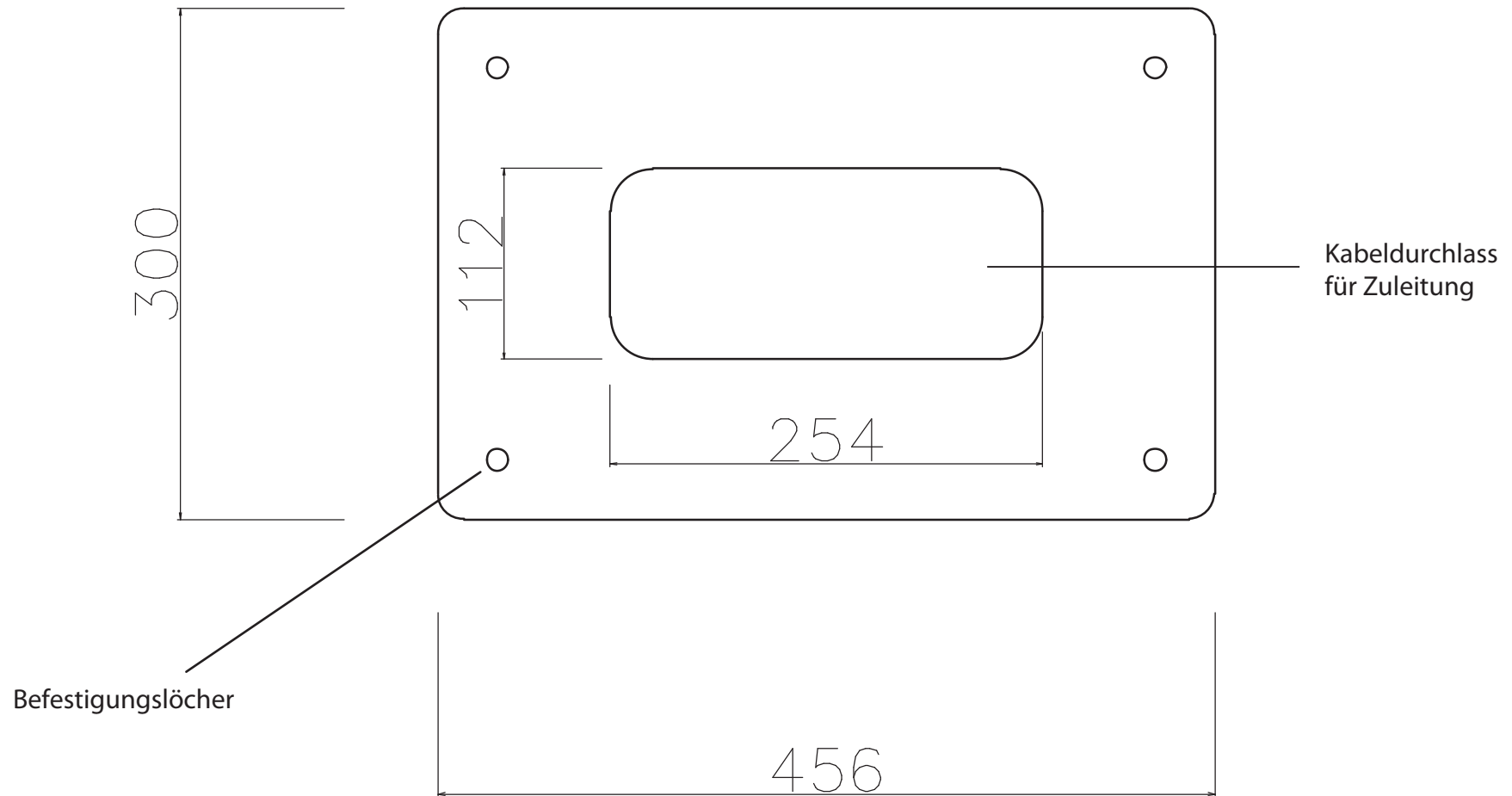

Das Fundament sollte umlaufend ca. 5 cm größer und ca. 80 cm tief (Frostgrenze) sein. Das Fundament muß eben und waagrecht sein.
 Betonfestigkeitsklasse: C20/25.

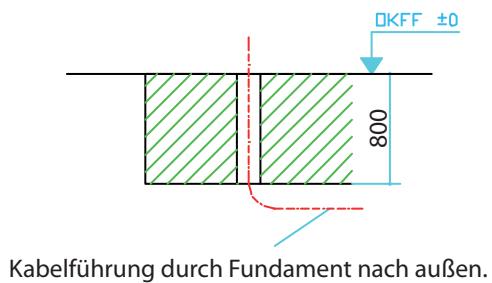

Fundament

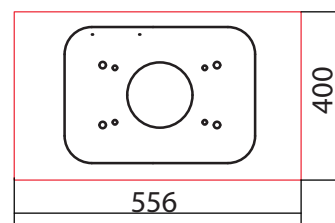

BAUER	
Bezeichnung:	Wallbox Duo Bodenplatte 456mmx300mm
Projektleiter:	
Datum:	16.01.2019